

Article number: 435700024

Description: Rota-fix shaft-hub connection K 24x47

Note: Self centering. Medium torque

Measures

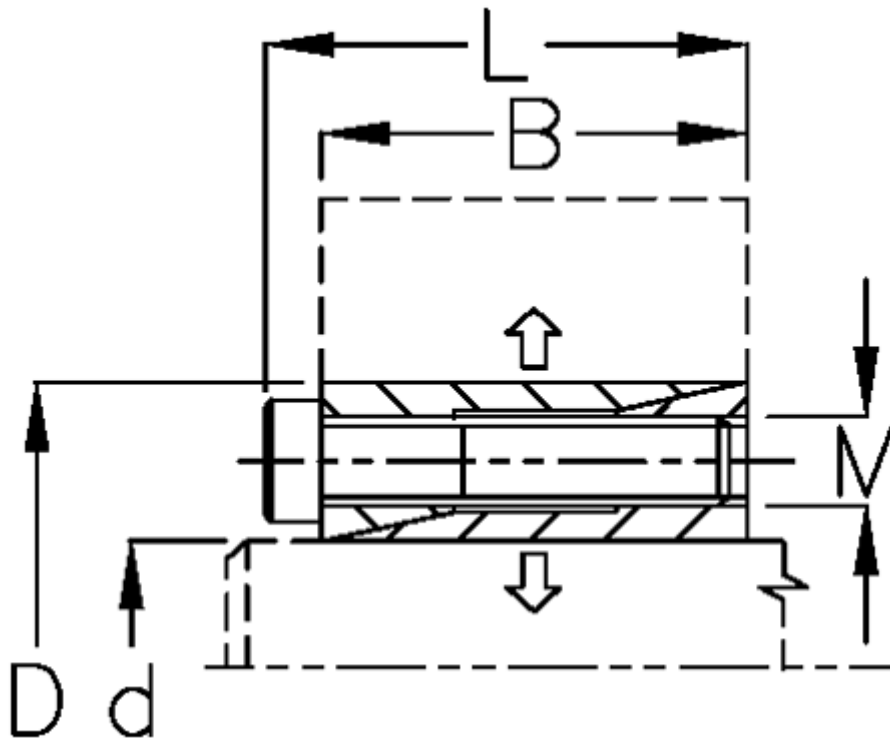

B mm	= 26
d mm	= 24.00
D mm	= 47
Fit tolerance	= Aksel h8, Nav H8
F kN torque	= 20.0
L mm	= 32.0
M mm	= M6
P N/mm ² surface pressure on shaft/hub	= 75

Surface roughness	= R? ? 3.2 µm
T N m torque	= 250
Ts N m bolt tightening torque	= 16.5